

Safety Information

Warning	<ul style="list-style-type: none"> Do not bump, apply excessive stress or scratch the lamp, as the lamp is glass product filled with high pressure gas (otherwise it could cause an injury from lamp breakage). Do not open the lamp housing during lamp operation or until the lamp properly cooled down after the lamp is turned off. He internal pressure of the lamp is especially high when it operation and immediately after it is turned off (otherwise it could cause an injury from lamp breakage). Do not touch the lamp during lamp operation or until the lamp properly cooled down after the lamp is turned off (otherwise it could cause a burn). Do not operate the lamp in close proximity to paper, cloth or any other combustible material during lamp operation or until the lamp properly cooled down after the lamp is turned off (otherwise it could cause a fire).
	<ul style="list-style-type: none"> Transport, store and dispose of lamps (including used lamps) in original packaging and the protective over if attached (otherwise it could cause an injury from lamp breakage). Wear a protective covering for the face and neck, and long sleeves when installing or removing the lamp to or from equipment (otherwise it could cause an injury from lamp breakage).
Caution	<ul style="list-style-type: none"> Turn off the power supply to the lamp when installing or removing the lamp to or from equipment (otherwise it could cause an electric shock).
	<ul style="list-style-type: none"> Do not look directly or indirectly at the light from the lamp without adequate eye protection (otherwise it could cause eye pain or damage to vision). Do not expose bare skin directly or indirectly to the lamp emission (otherwise it could cause skin irritation).
	<ul style="list-style-type: none"> Use the lamp only in equipment for which approved, and only after reading and understanding the operating manual for such equipment. Do not make any other use of the lamp (otherwise it could cause lamp breakage or damage to the equipment). Do not touch quartz envelope with bare hands. If quartz envelope is dirty, wipe with alcohol-soaked clean cloth (otherwise it could cause lamp breakage or shorten lamp life). Do not subject the lamp to vibration or shock (otherwise it could cause lamp breakage or shorten lamp life). Do not throw away the original packaging and the protective cover if attached, as they will be needed in transporting or disposing of the lamp. Store the lamp in its original protective packaging and the protective cover if attached. Transport the lamp In its original protective packaging and the protective cover if attached (otherwise it could cause lamp breakage).
	<ul style="list-style-type: none"> Before installing the lamp in equipment, make sure that there is no rust, burning or discoloration where electrical connections are made between the lamp and the equipment. Install the lamp in the correct polarity (otherwise it could cause lamp breakage or shorten lamp life). Install the lamp properly in the equipment, without twisting, bending or otherwise applying excessive stress to the lamp (otherwise it could cause lamp breakage, failure of the lamp to remain in place, or shorten lamp life). Properly attach the lamp lead wire to the terminal, and without applying excessive stress to the lamp (otherwise it could cause overheating or smoke). Either leave the protective cover is attached, on the lamp during installation and remove it when installation is complete, or remove the protective cover immediately prior to installation. Use proper care in installing or removing the lamp to avoid bumping the lamp against anything (otherwise it could cause lamp breakage or damage to the equipment). Place the protective cover if attached, on the lamp immediately before or after removal of the lamp.
Caution	<ul style="list-style-type: none"> Do not use where volatiles are present (otherwise it could cause fire or explosion). When a lamp has been used for longer than its rated life, it must be replaced. The risk of lamp breakage increases (otherwise it could cause lamp breakage).
	<ul style="list-style-type: none"> In the event the lamp ruptures during operation, leave the area and ventilate the area for 30 minutes. There is possibility of inhaling mercury fumes (inhaling mercury fumes could be harmful to health). After the lamp and lamp housing have cooled down, remove any remaining mercury with a packing tape, a thin paper, or a syringe. In the event of lamp breakage, mercury could be released. Collect any mercury with a packing tape, a thin paper, or a syringe. Place any collected mercury and the materials used for correcting mercury in an airtight nonmetallic container. If mercury fumes are inhaled, please consult a physician for medical advice.
	<ul style="list-style-type: none"> On disposal, inform the recycler that the lamp contains mercury and is filled with high pressure gas.

Lamp Disposal Information North America Only Hg-LAMP CONTAINS MERCURY
 Manage in Accord with Disposal Laws
 See: www.lamprecycle.org or 1-800-895-8842

USHIO

USHIO AMERICA, INC.

5440 Cerritos Avenue, Cypress, CA 90630, U.S.A.
 TEL +1 714-236-8600 FAX +1 714-229-3180
 URL www.ushio.com

USHIO EUROPE B.V.

Breguetlaan 16-18, 1438 BC Oude Meer, the Netherlands
 TEL +31 20-446-9333 FAX +31 20-446-0360
 URL www.ushio.eu/

USHIO ASIA PACIFIC PTE. LTD.

28 Genting Lane, #05-05, Platinum 28, Singapore 349585
 TEL +65 6274-5311 FAX +65 6274-5300
 URL www.ushioasiapacific.com/

USHIO ASIA PACIFIC (THAILAND) LTD.

202 The Le Concorde Tower, 20th Floor, Room No.2006, Ratchadapisek Road, Huaykwang, Bangkok 10320 Thailand
 TEL +66 2-694-1440 FAX +66 2-694-1770
 URL www.ushioasiapacific.com/

USHIO TAIWAN, INC.

8F, No.4, Sec.1, Zhongxiao W.Rd., Taipei 10041, Taiwan, R.O.C.
 TEL +886-2-2312-3358 FAX +886-2-2312-3858
 URL www.ushio.com.tw/

USHIO KOREA, INC.

(Seocho-dong, Deokheung Bldg), 14F, 363, Gangnam-daero, Seocho-gu, Seoul, 137-858 Rep. of Korea
 TEL +82 2-587-1115 FAX +82 2-587-1118
 URL www.ushio.co.kr/

USHIO HONG KONG LTD.

Suites 3113-14, 31/F, Tower 6, The Gateway, 9 Canton Road, Tsim Sha Tsui, Kowloon, Hong Kong
 TEL +852 2756-7880 FAX +852 2798-9861
 URL www.ushio.com.hk

USHIO SHANGHAI, INC.

Hang Seng Bank Tower, 10/F, 1000 Lujiazui Ring Road, Pudong New Area, Shanghai, 200120, P.R.C.
 TEL +86 21-6841-1135 FAX +86 21-6841-1150
 URL www.ushio.com.cn/

USHIO SHENZHEN, INC.

Suites A, E, 10/F, Building A, Honglong Century Plaza, NO.3001, HePing Road, LuoHu District, ShenZhen, 518001 P.R.C.
 TEL +86 755-8207-0162 FAX +86 755-8207-0161
 URL www.ushio.com.cn/

The specifications on this sheet supercede all previously published specifications and may be subject to change for design and specification improvement without prior notice.

USHIO

UXM-501MD

USHIO Deep UV Lamp



Features & Benefits

- Enhanced electrodes design for precise positioning and high arc stability.
- Improved manufacturing process enables extended life.
- USHIO developed product with tightly controlled ISO quality processes.

Applications

- Semiconductor circuit formation
- Liquid crystal color filter pattern formation
- Printed substrate pattern formation
- Surface Reform
- UV hardening

Model

UXM-501MD

Initial specifications

Wattage Power Range	W	500
Rated Lamp Current	A	20
Operating Voltage ^{※3}	V	25±2
Useful Power Range	A	18~22

※3 As the arc gap increases by electrode evaporation, lamp voltage increases.

Specifications

Cold Arc Gap	mm	3
Weight	g	79
Avg Rated Life ^{※4}	h	600

※4 Be sure to replace the lamp at the rated lamp life. Otherwise it could cause an injury if it bursts. Average rated life represents the average life span when lit continuously at the rated power. The average rated life terminates when either ① or ② takes place. ① When the horizontal irradiance or total luminous flux are reduced to 70% of the initial values. ② When lighting is no longer possible.

Intensity (Representative Values) ^{※5}

Horizontal Liminous Intensity ($\mu\text{W}/\text{cm}^2$) (1m from lamp)	210~300nm	276	360~370nm	184
	Total Luminous Flux (lm)		20300	

※5 $1\text{mW}/\text{cm}^2=1000\mu\text{W}/\text{cm}^2$

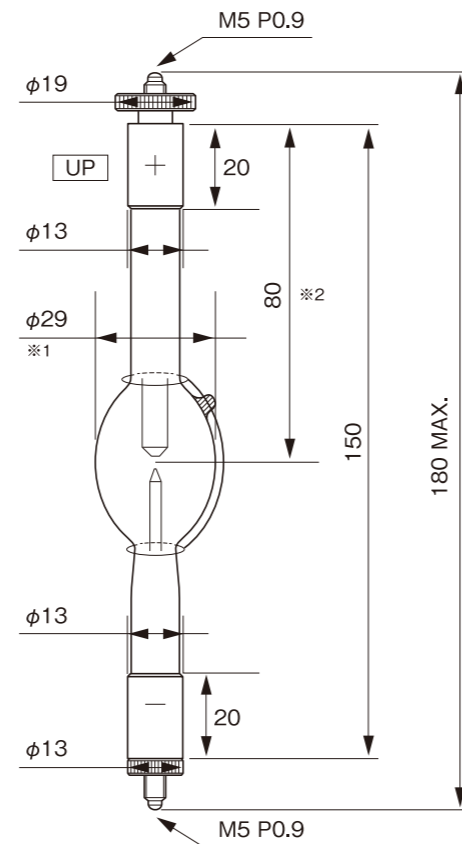

※1 Diameter excludes height of protuberance on lamp bulb.
※2 Length to the center of the cold arc gap.

Operating Condition ^{※6}

Power Supply

Type	Constant Power Control (suggested)	
Current Ripple	P-P, %MAX	3
Trigger Voltage ^{※7}	Min, kV AC	35
Supply Voltage ^{※8}	Min, V	135

Lamp House

Position	°	Vertical ±15
Base Temperature	°C, MAX	200
Bulb Temperature	°C	650~750

Forced Cooling ^{※9} Necessary

※6 Use in well-designed and power supply. Otherwise it may cause lamp bursts or shorten life.

※7 Voltage to ignite lamp. Exhausted lamp needs higher voltage to be ignited as electrodes evaporation.

※8 Open circuit voltage to light the lamp.

※9 Adjust the cooling to obtain the center of the operating voltage range.

Lamp Life Curve (Typical Value) ^{※10}

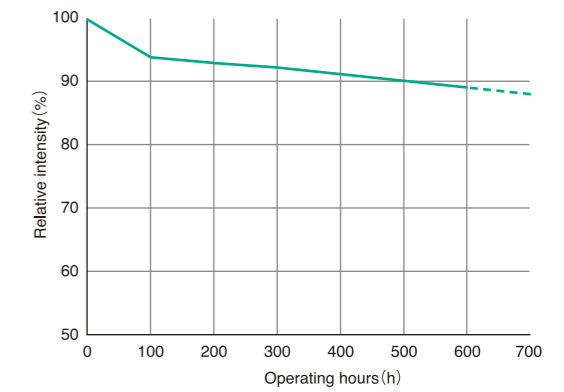

※10 Horizontal luminous intensity at continuous use. Frequent switch may cause shorter life.

Spectral Distribution ^{※11}

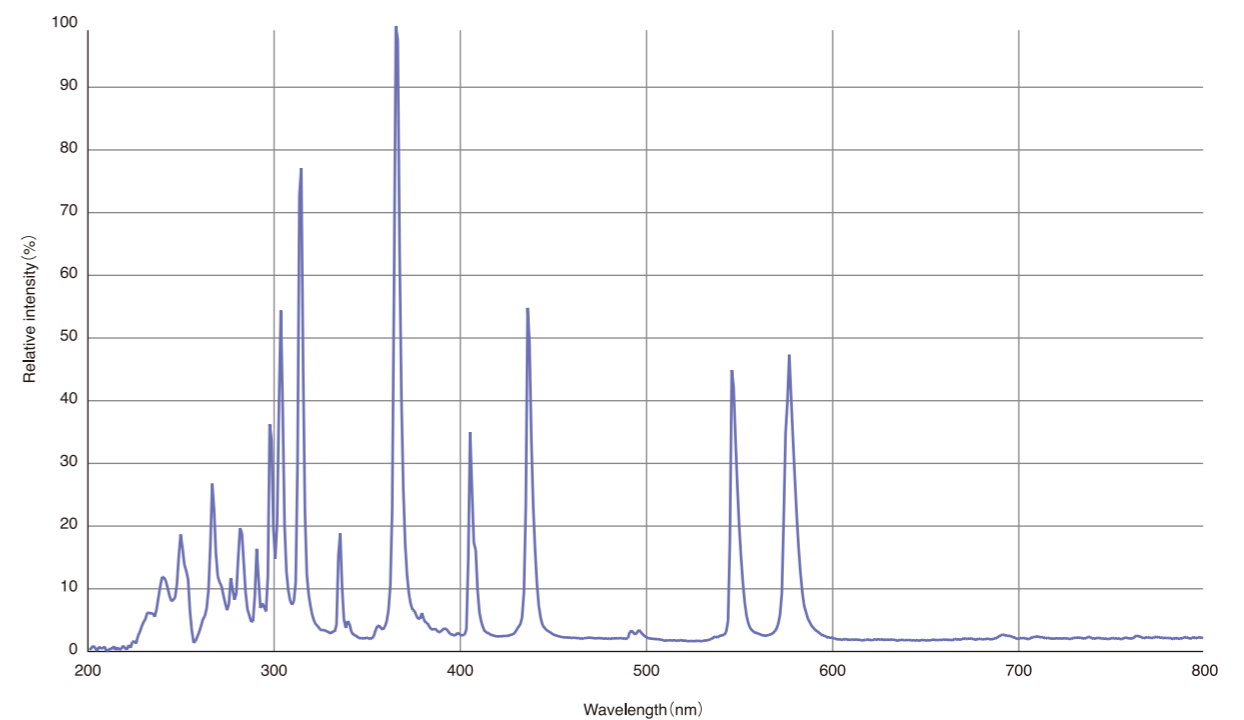

※11 Reference value at horizontal measurement.